

**ALUSIGNPANEL**<sup>®</sup>  
Aluminum Composite Panel

# COLOR CHART

Professional Manufacturer Since 2000



Decoration board  
(PE ACP)



Digital Printing Board  
(Printable ACP)



### PROFESSIONAL MANUFACTURER SINCE 2000

- \* Company founded on 2000 & located in Wenzhou city, Zhejiang province, with over 154 employees
- \* Supply A2 & B1 FR ACP , PVDF ACP , FE ACP , Mirror & Brushed & Stone & Wooden colors ACP , A2 FR ACCP and Color coated Aluminum Coil etc .

### TO MAKE A TRUSTED BRAND OF ACP WORLDWIDE

- \* Company with ISO9001, ISO14001 & OHSAS18001 certification
- Product series have passed UL, CE, SGS, SGS for Fireproof, CTC
- \* Company main brand ALUSIGNPANEL & YBOND, products widely exported to USA, Canada, Mexico, Brazil, Chile, Poland, France, Germany, Australia, Philippines, UAE, Nigeria and so on.



### FACTORY WITH 12 HIGH-SPEED PRODUCTION LINES

- \* 6 ACP production lines, with a daily output of over 32,000 m<sup>2</sup>
- \* 1 A2 FR ACCP production line, with a daily output of 5,000 m<sup>2</sup>
- \* 2 automated coating lines, with a monthly output of over 1,200 tons
- \* 3 polyethylene plastic production lines

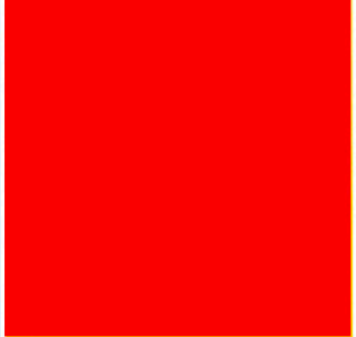

# METALLIC & SOLID COLORS



SJ-8001 Flash Silver

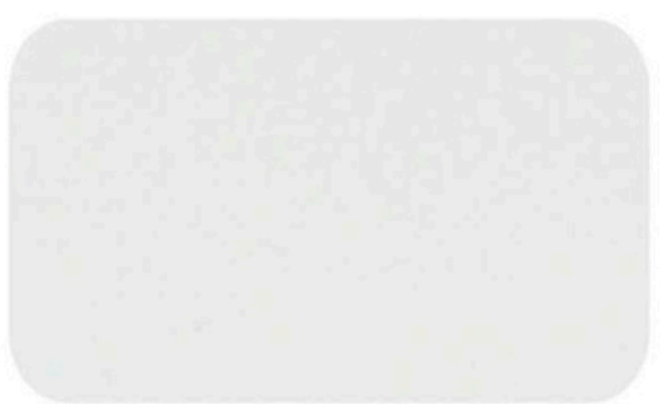

SJ-8011 Pure White



SJ-8013 Off White



SJ-8002 Silver Grey



SJ-8014 Ivory White



SJ-8049 Black



SJ-8004 Champagne Silver

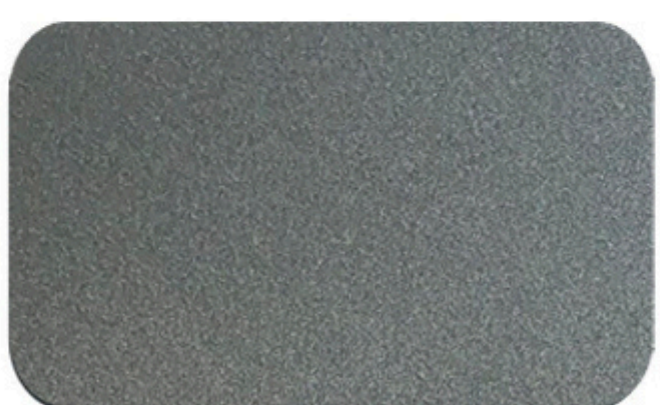

SJ-8005 Grey Metallic

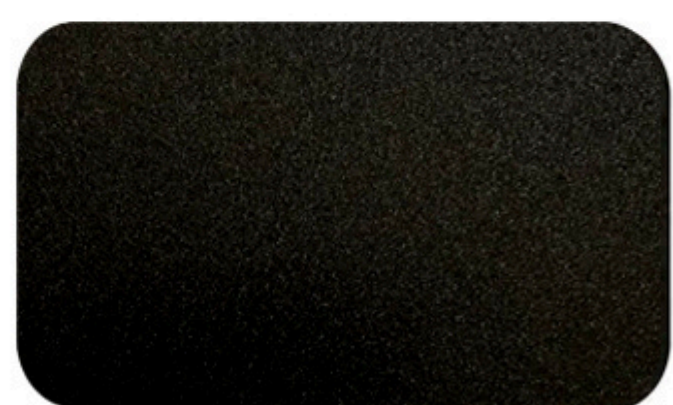

SJ-8048 Galaxy Black

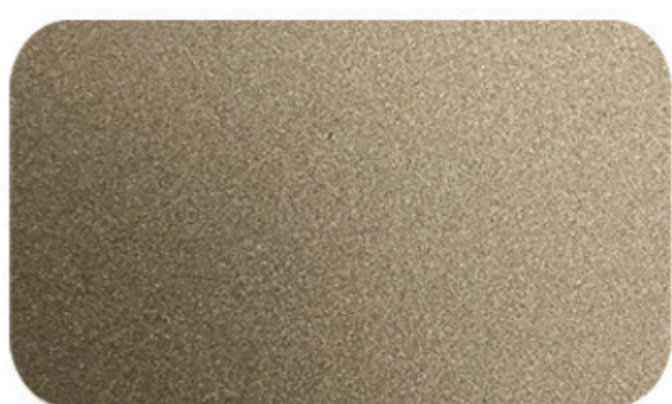

SJ-8006 Champagne Golden



SJ-8008 Flash Gold

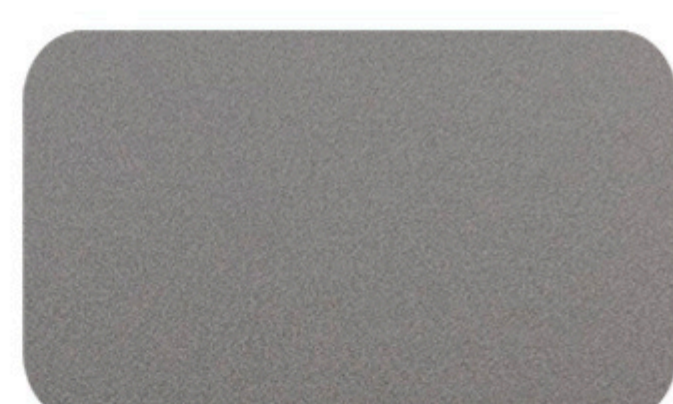

SJ-8061 Dark Grey Metallic

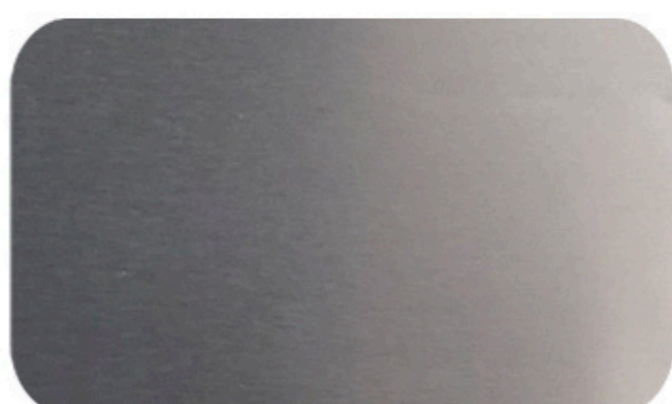

SJ-8003 Aluminium

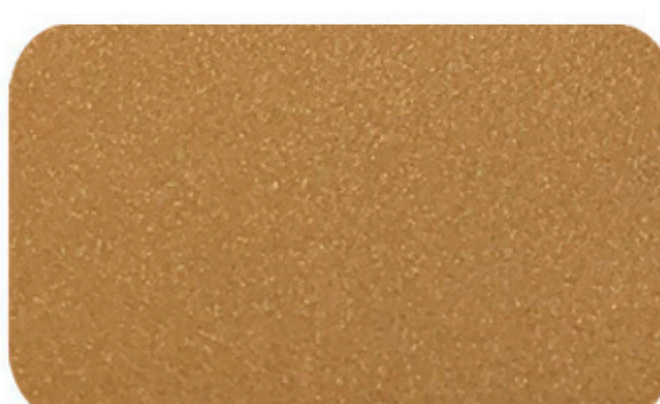

SJ-8009 Brown Copper



SJ-8034 C-Red

Colors for reference only



Office Buildings  
(PVDF Nano ACP)



Outdoors Wall  
(PVDF ACP)



# METALLIC & SOLID COLORS



SJ-8037 Pure Yellow



SJ-8016 Sky Blue



SJ-8025 Post Green



SJ-8038 Lemon Yellow



SJ-8017 Telecom Blue



SJ-8021 Apple Green



SJ-8040 Orange Red

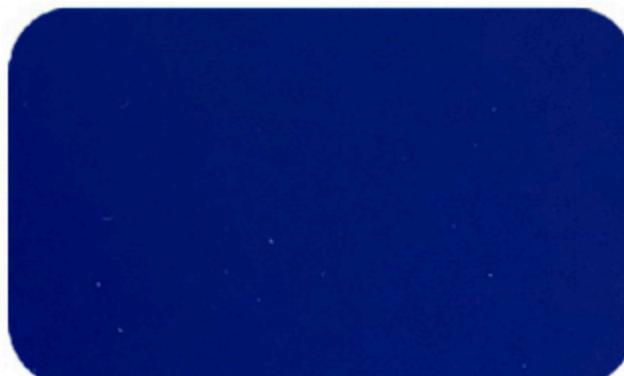

SJ-8019 Sea Blue

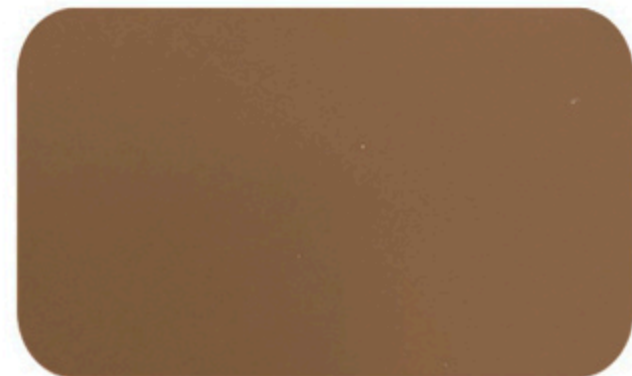

SJ-8046 Coffee Brown



SJ-8051 Light Gray

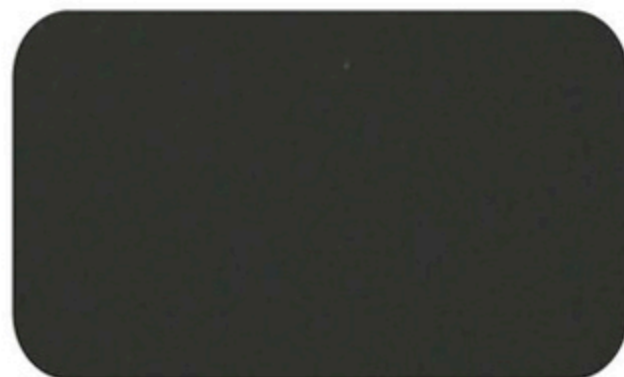

SJ-8052 Dark Gray



SJ-8043 Deep Rose

# ANTI-SCRATCH COLORS

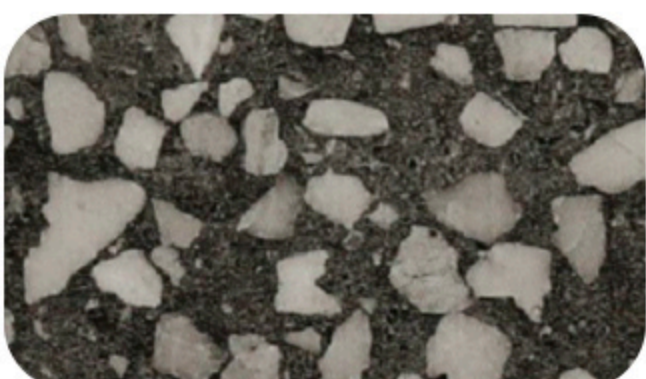

SJ2020-26 Anti-scratch Stone

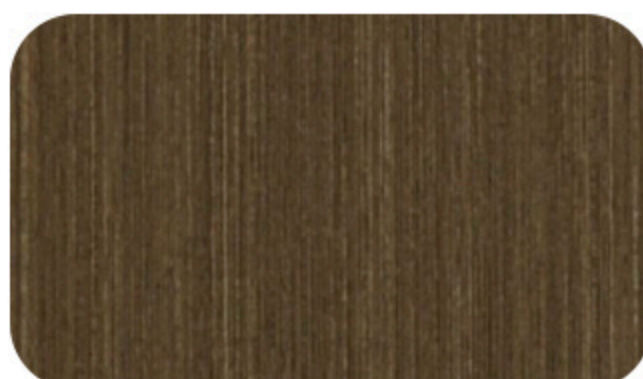

SJ2020-07 Anti-scratch Wood



SJ9915 Anti-scratch Wood



Indoor Decoration  
(PE ACP)



Shop Decoration  
(PE ACP)



# GLOSSY COLORS

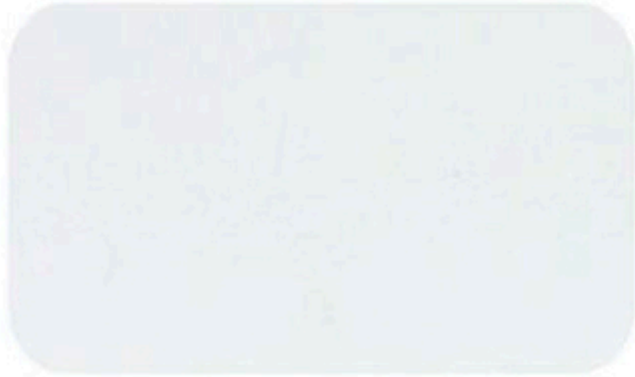

SJ-8825 Glossy White



SJ-8826 Glossy Red



SJ-8827 Glossy Green



SJ-8828 Glossy Black



SJ-8831 Glossy Yellow

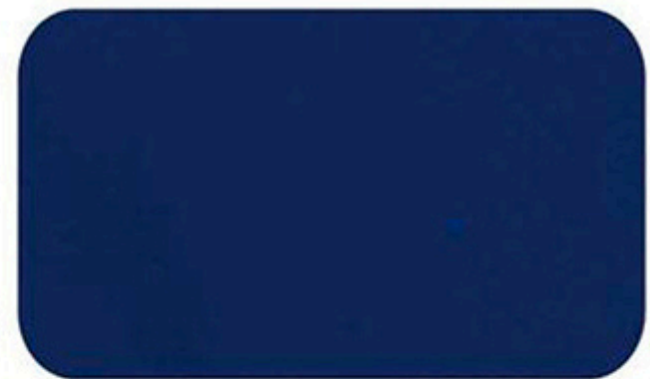

SJ-8832 Glossy Blue

# MIRROR & BRUSHED & TIMBER & STONE & PEARL COLORS

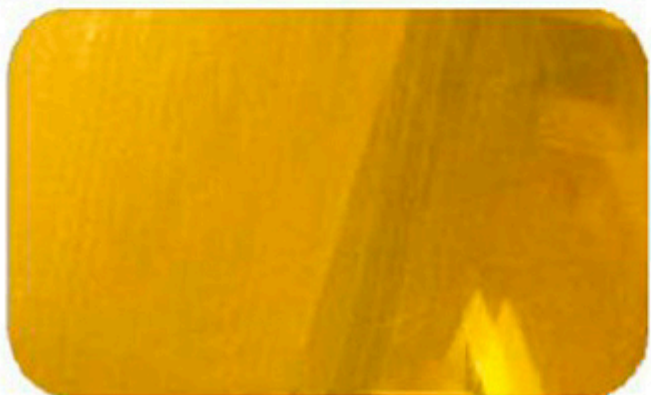

SJ-8822 Golden Mirror



SJ-8823 Silver Mirror



SJ-8053 Brushed Silver

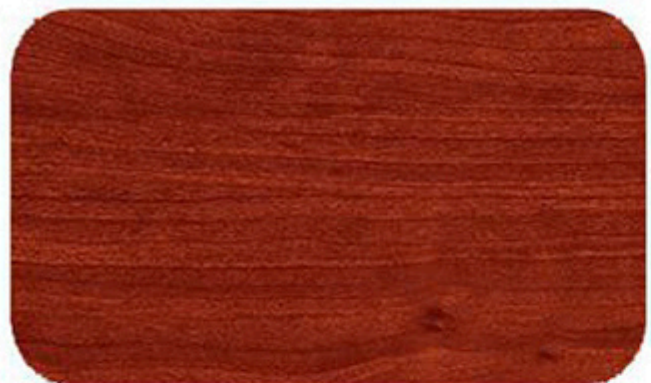

SJ-T1 Timber Look

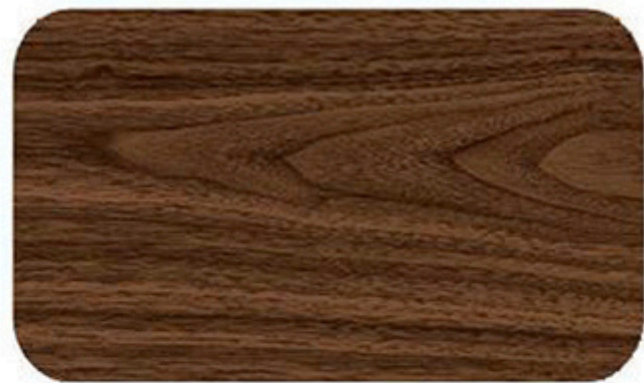

SJ-T2 Timber Look



SJ-8058 Brushed Golden



SJ-T3 Timber Look



SJ-S1 Stone Look

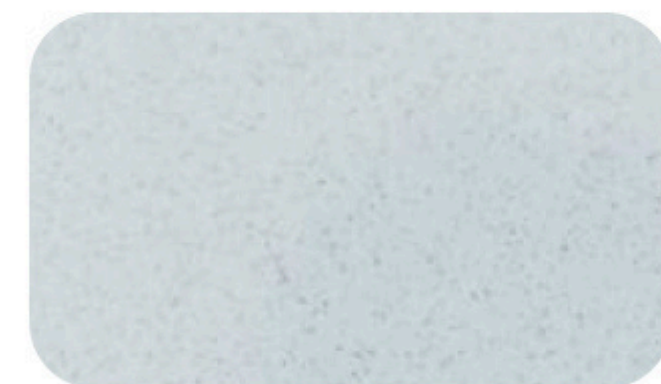

SJ-8841 Pearl White

# SPECIFICATION



Width	1220mm / 1250mm / 1500mm / 2000mm
Length	Upon request, recommend 2440mm, 3050mm, 5000mm
Panel Thickness	2.0mm - 6.0mm (recommend 3mm, 4mm)
Alu. Skin Thickness	0.10mm - 0.50mm (popular 0.21mm, 0.30mm, 0.50mm)
Coating	PE / HDPE / PVDF / FEVE
Core Material	Polyethylene Plastic (LDPE) or FR ( A2 & B1 Fire Resistant )
Colors	Refer to factory's color chart or customize
Protective Film	Alusignpanel , Ybond , Blank film or OEM designs
Standard Size	1220mm × 2440mm (4' × 8')   1500mm × 3050mm (5' × 10')

# APPLICATIONS & PROJECTS

- Exterior wall cladding of commercial buildings, hotel, apartment, stadium, hospital, restaurant, shopping mall and so on
- Decorative material for the bank, store, gas station, gallery
- Billboard, signage board, display, partition board
- Ceiling, kitchen cabinet, balcony, partition, furniture board
- Tunnel, subway, vehicle bodies, and industrial usage

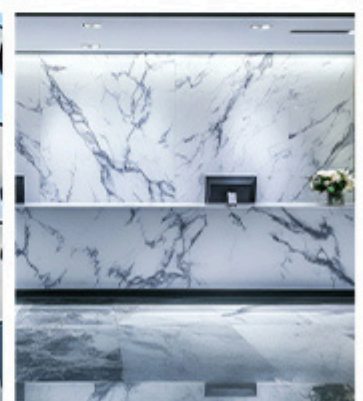
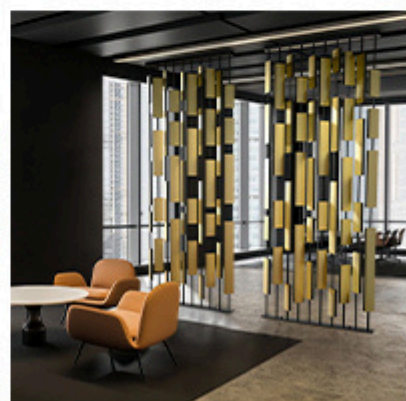

# MAIN STRUCTURE

ALUSIGNPANEL Protective Film

Top Aluminum Skin with PE/PVDF coating

Polymeric membrane

Standard LDPE Core & Optional FR Core

Polymeric membrane

Bottom Aluminum Skin with service coating



Easy Maintenance



Easy Processing



Non-Toxicity and Safety

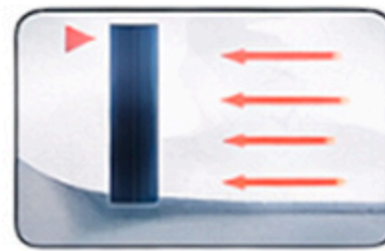

Super Peeling Strength



Excellent Coating Property

# PROCESSING



Sawing

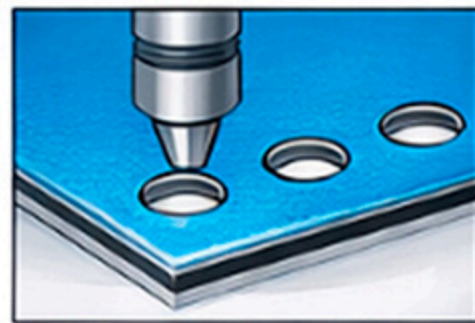

Drilling



Slotting



Bending

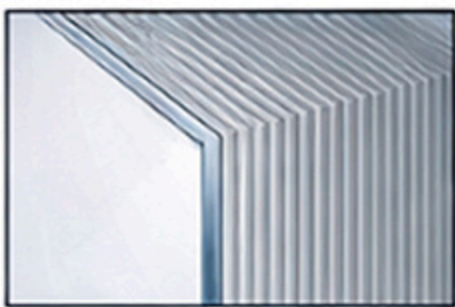

Folding



Roll Bending



Gluing



Punching

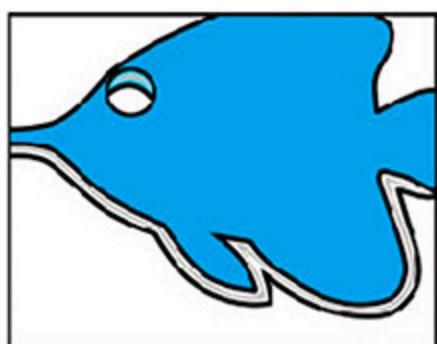

Contour Cutting



Digital Printing



Silk-screen

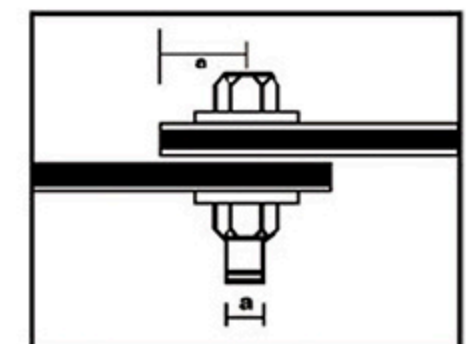

Clamping & Bolting

MAKE YOUR INNOVATION

 **ALUSIGNPANEL**®

Aluminum Composite Panel



**WENZHOU JIXIANG COMPOSITE PANEL CO., LTD.**

NO.228 WEISAN ROAD, YUEQING ECONOMY INDUSTRY ZONE, WENZHOU CITY, ZHEJIANG PROVINCE, CHINA. 325600

+86 577 62999101 +86 577 62999102 [www.alusignpanel.com](http://www.alusignpanel.com) [info@alusignpanel.com](mailto:info@alusignpanel.com)

[alusignpanel](https://www.facebook.com/alusignpanel) [@alusignpanelglobal](https://www.instagram.com/alusignpanelglobal)